

apollo | x16

Thunderbolt 3 Audio Interface



Apollo x16 Hardware Manual

Manual Version 080828



www.uaudio.com

A Letter from Bill Putnam Jr.

Thank you for choosing this Apollo X Series audio interface to become a part of your studio. We know that any new piece of gear requires an investment of time and money — and our goal is to make your investment pay off.

Universal Audio interfaces like Apollo X exemplify a commitment to craftsmanship that we've forged over the past 60 years — from our original founding in the 1950s by my father, Bill Putnam Sr., to our current mission combining the best of both classic analog and modern digital audio technologies.

Starting with its ultra high-quality I/O and superior A/D and D/A conversion, Apollo X is designed to set new benchmarks in sonic performance. Breakthrough fidelity is just the beginning, however, as Apollo X's onboard HEXA Core processing lets you power the full range of UAD plug-ins, including classic mic preamps, EQs, dynamics processors, reverbs, guitar amps, and much more. With more than 100 acclaimed UAD plug-ins at your fingertips, the sonic choices are limitless.

At UA, we are dedicated to the idea that technology should serve the creative process, inspiring our customers to go further. These are the ideals my father embodied with his classic designs, and we like to think this spirit lives on today in products like Apollo X.

Please feel free to reach out to us via our website www.uaudio.com, and via our social media channels. We look forward to hearing from you, and thank you once again for choosing Universal Audio.

Sincerely,

A handwritten signature in black ink, appearing to read 'Bill Putnam Jr.', with a stylized, cursive script.

Bill Putnam Jr.

Table Of Contents

Tip: Click any section or page number to jump directly to that page.

A Letter from Bill Putnam Jr.	2
Introduction	4
Apollo x16 Features	6
Apollo x16 Documentation Overview	8
Additional Resources	9
Front Panel	10
Rear Panel	16
Digital I/O	17
Analog I/O	19
Interconnections.....	22
Installation Notes	22
Connection Notes	22
Typical Setup	24
Apollo Expanded: Multi-Unit Thunderbolt 3 Wiring.....	25
Software Setup.....	26
Specifications	27
Hardware Block Diagram	30
DB25 Wiring	31
Troubleshooting	32
Notices.....	33
Warranty	33
Repair Service	33
Maintenance	33
Important Safety Information	34
Technical Support.....	37
Universal Audio Knowledge Base.....	37
YouTube Support Channel.....	37
Universal Audio Community Forums	37
Contact Universal Audio Support.....	37

Introduction

16 Channels of Elite Audio Conversion, HEXA Core Processing and Surround Sound Monitoring.

The flagship Apollo x16 allows music producers, project, and post-production studios to track, overdub, and mix with new world-beating A/D and D/A conversion, HEXA Core UAD plug-in processing, and 7.1 surround sound monitoring[†] — all in a sleek rackmount Thunderbolt 3 audio interface for Mac or PC.

Built upon UA's 60-year heritage of audio craftsmanship, this 18 x 20 interface boasts the widest dynamic range (133 dB) and lowest THD+N (-129 dB), of any integrated audio interface on the market. Plus, with all-new HEXA Core processing, you'll get 50% more DSP for running acclaimed UAD Powered Plug-Ins in real time.

In addition to its elite-class audio conversion, Apollo x16 features selectable operating level for compatibility with professional +24 dBu gear, as well as an integrated monitor controller and built-in talkback mic.

- Experience elite-class A/D and D/A conversion with the widest dynamic range and lowest signal to noise of any integrated audio interface available
- Track and mix with powerful HEXA Core processing, featuring 6 UAD DSP chips for running more award-winning UAD Powered Plug-Ins in real time
- Easily connect to professional studio gear with 16 x 16 analog I/O via DB-25 connections, plus switchable +24 / +20 dBu headroom settings
- Work in surround formats up to 7.1[†], complete with speaker calibration and fold-down

*[†]Surround sound support for Apollo X will be in a future software release.
For the latest Apollo X software, visit www.uaudio.com.*

Elite-Class A/D and D/A Conversion

With thousands of chart-topping songs and hundreds of Grammy-winning albums under their belt, Apollo interfaces are no strangers to tracking stellar-sounding records. To improve on the previous generation Apollo interface's class-leading audio conversion, UA engineers obsessively auditioned the latest A/D and D/A converters — ultimately pairing elite-class 24-bit/192 kHz converters with all-new analog circuitry for an ultra-pristine signal path.

With 133 dB dynamic range and THD+N of -129 dB, the Apollo x16's open, natural sound quality bests every interface in its class — regardless of price — and is the perfect starting point for applying UAD processing.

**All trademarks are recognized as property of their respective owners. Individual UAD Powered Plug-Ins sold separately.*

Realtime UAD HEXA Core Processing

Apollo x16 features new HEXA Core processing, with six DSP chips and 50% more UAD plug-in processing power than previous Apollos. This lets you run more UAD plug-ins, whether you're tracking in real time with channel strips from Neve, Manley, Helios, or API, or running high UAD plug-in counts when mixing in your DAW.

From the tube warmth of Pultec EQs on guitars to the musical tube limiting of the LA-2A on vocals, or the pump of a genuine 1176 or Fairchild 670 tube compressor on drums, your recordings will take a giant leap forward with a rich, three-dimensional analog sound that UAD plug-ins provide.

A Full Suite of Classic Analog Processing Onboard

Of course, a hallmark feature of Apollo is its Realtime UAD Processing, letting you run the full library of UAD plug-ins with near-zero latency. Apollo x16 includes the Realtime Analog Classics Plus plug-in bundle, so you can record and mix with the world's only authentic Teletronix LA-2A, 1176LN, and Fairchild compressors, Pultec EQs, and many more.

Access the World of UAD Powered Plug-Ins

Going beyond the included Realtime Analog Classics Plus plug-ins, Apollo x16 lets you tap into the full UAD Powered Plug-In library of name-brand vintage EQs, compressors, reverbs, tape machines, channel strips, and more — at near-zero latency, regardless of your audio software's buffer size and without taxing your computer's CPU.

With exclusive emulations from SSL, Neve, Studer, Manley, API, Ampex, Lexicon, Fender, and more,* it's like having a studio full of iconic analog gear, in a single rack space. And unlike competing interfaces, these award-winning DSP-powered plug-ins are also available in your DAW for mixing.

Surround Sound Monitoring† and +24dBu Operation

With comprehensive surround monitoring support for formats up to 7.1, Apollo x16 is a boon for engineers and producers working on audio and music for video games, television, and the web. In addition, Apollo x16 offers selectable +24 dBu operation for out-of-the-box compatibility with professional mixing consoles and other high-end pro audio equipment.

Build a Networked Studio System Over Thunderbolt

Apollo x16 offers 18 x 20 simultaneous inputs/outputs (16 x 16 analog I/O) and two built-in Thunderbolt 3 ports, which are backwards-compatible with Thunderbolt 1 and 2 Macs via adapter (sold separately). This allows users of any Thunderbolt-equipped Apollo Twin or Apollo rackmount audio interfaces to easily combine up to four Apollos and six total UAD-2 devices — adding fast, high-bandwidth I/O and DSP as your studio grows.

†Surround sound support for Apollo X will be in a future software release.

For the latest Apollo X software, visit www.uaudio.com.

**All trademarks are recognized as property of their respective owners. Individual UAD Powered Plug-Ins sold separately.*

Apollo x16 Features

Key Features:

- 18 x 20 Thunderbolt 3 audio interface with class-leading 24-bit/192 KHz conversion
- HEXA Core Realtime UAD Processing for tracking through UAD plug-ins at near-zero latency, regardless of audio buffer size
- Surround monitor controller up to 7.1 format[†]
- Includes “Realtime Analog Classics Plus” UAD plug-in bundle featuring UA 610-B Tube Preamp; Legacy Pultec EQ, LA-2A, and 1176 compressors; Marshall Plexi Classic; Ampeg SVT-VR Classic and more
- UAD-2 HEXA Core processing onboard for additional mixing horsepower for Pro Tools, Logic, Cubase, Ableton, and other major DAWs
- Combine up to 4 Thunderbolt-equipped Apollos and 6 total UAD devices; backward-compatible with Thunderbolt 1 and 2 via optional adapter
- Selectable +24 dBu operation for easy compatibility with professional mixing consoles and tape machines
- Convenient front panel monitoring functions including Alt Speakers, Talkback mic, and assignable Dim or Mono
- Uncompromising UA analog design, superior components, and premium build quality
- Free, industry-leading technical support — on the phone and online — from knowledgeable audio engineers

Audio Interface

- Sample rates up to 192 kHz at 24-bit word length
- 16 x 18 simultaneous analog input/output channels:
 - 16 channels of analog-to-digital conversion via line inputs on dual DB25 connectors
 - 18 channels of digital-to-analog conversion:
 - 16 line outputs via dual DB25 connectors
 - Stereo monitor outputs via dual XLR connectors
- Adjustable reference levels for all analog I/O (+4 dBu or -10 dBV)
- Two channels of AES/EBU digital I/O with optional sample rate conversion on input
- Front panel pre-fader metering of analog signal input or output levels
- Two Thunderbolt 3 ports for daisy-chaining other Thunderbolt devices

*[†]Surround sound support for Apollo X will be in a future software release.
For the latest Apollo X software, visit www.uaudio.com.*

**All trademarks are recognized as property of their respective owners. Individual UAD Powered Plug-Ins sold separately.*

Monitoring

- Independently-addressable stereo monitor outputs (in addition to 16 line outputs)
- Front panel control of monitor levels and muting
- Front panel pre-fader metering of monitor bus levels
- Digital AES/EBU outputs can mirror the analog monitor outputs

UAD-2 HEXA Inside

- Six SHARC® DSP processors
- Realtime UAD Processing on all of Apollo x16's analog and AES/EBU inputs
- Same features and functionality as other UAD-2 products when used with DAW
- Can be combined with other UAD-2 devices for increased mixing DSP
- Complete UAD Powered Plug-Ins library is available online

Software

Console application:

- Analog-style control interface for realtime monitoring and tracking
- Enables Realtime UAD Processing with UAD plug-ins
- Remote control of Apollo x16 features and functionality
- Virtual I/O for routing DAW tracks through Console

Console Recall plug-in:

- Saves Console configurations inside DAW sessions for easy recall
- Convenient access to Console's monitor controls via DAW plug-in
- VST, RTAS, AAX 64, and Audio Units plug-in formats

UAD Meter & Control Panel application:

- Configures global UAD settings and monitors system usage

Other

- Easy firmware updates
- 1U rack-mountable form factor
- One year warranty includes parts and labor

Apollo x16 Documentation Overview

Documentation for Apollo x16 and UAD Powered Plug-Ins are separated by areas of functionality, as described below. The user manuals are placed on the system drive during software installation, and they can be downloaded at help.uaudio.com.

***Note:** All manual files are in PDF format. PDF files require a free PDF reader application such as [Acrobat Reader](#) (Mac & Windows) or [Preview](#) (Mac).*

Apollo Hardware Manuals

Each Apollo model has a unique hardware manual. The Apollo hardware manuals contain complete hardware-related details about one specific Apollo model. Included are detailed descriptions of all hardware features, controls, connectors, and specifications.

***Note:** Each hardware manual contains the unique Apollo model in the file name.*

Apollo Software Manual

The Apollo Software Manual is the companion guide to the Apollo hardware manuals. It contains detailed information about how to configure and control all Apollo software features using the Console application, Console Settings window, and Console Recall plug-in. Refer to the Apollo Software Manual to learn how to operate the software tools and integrate Apollo's functionality into the DAW environment.

***Note:** Each Apollo connection protocol (Thunderbolt, FireWire, USB) has a unique software manual.*

UAD Plug-Ins Manual

The features and functionality of all individual UAD Powered Plug-Ins is detailed in the UAD Plug-Ins Manual. Refer to this document to learn about the operation, controls, and user interface of each UAD plug-in that is developed by Universal Audio.

Direct Developer Plug-In Manuals

UAD Powered Plug-Ins includes plug-in titles created by our Direct Developer partners. Documentation for these 3rd-party plug-ins are separate files written and provided by the plug-in developers. The file names for these plug-in manuals are the same as the plug-in titles.

UAD System Manual

The UAD System Manual is the complete operation manual for Apollo's UAD-2 functionality and applies to the entire UAD-2 product family. It contains detailed information about installing and configuring UAD devices, the UAD Meter & Control Panel application, buying optional plug-ins at the UA online store, and more. It includes everything about UAD except Apollo-specific information and individual UAD plug-in descriptions.

Accessing Installed Documentation

Any of these methods can be used to access installed documentation:

- Choose “Documentation” from the Help menu within the Console application
- Click the “Product Manuals” button in the Help panel within the UAD Meter & Control Panel application
- Manuals are also available online at help.uaudio.com

Host DAW Documentation

Each host DAW software application has its own particular methods for configuring and using audio interfaces and plug-ins. Refer to the host DAW’s documentation for specific instructions about using audio interface and plug-in features within the DAW.

Additional Resources

For additional resources, or if you need to contact Universal Audio for assistance, see the [Technical Support](#) page.

Front Panel

This section describes the features and functionality of all controls and visual elements on the Apollo x16 front panel.

Tip: All front panel functions except *METER* and *POWER* can be controlled remotely with the included Console software application. Changes made with the front panel controls are mirrored in the Console application, and vice versa.

(1) Power Indicator (UA Logo)

The Universal Audio logo illuminates when the external power supply is properly connected to the AC outlet and the power input on the rear of the unit, and the Power switch (#14) is in the up position.

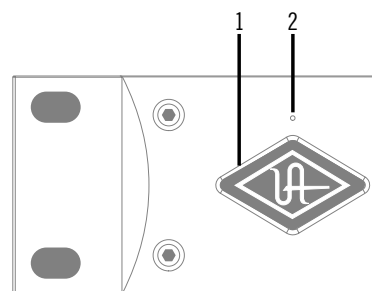

Power indicator and talkback microphone

(2) Talkback Microphone

The built-in talkback mic is located inside of this hole. The talkback function is configured and operated in the included Console software application.

Caution: The talkback microphone is sensitive. To avoid equipment damage, do not insert any object into the mic hole, apply pressurized air into the mic hole, or use a vacuum over the mic hole.

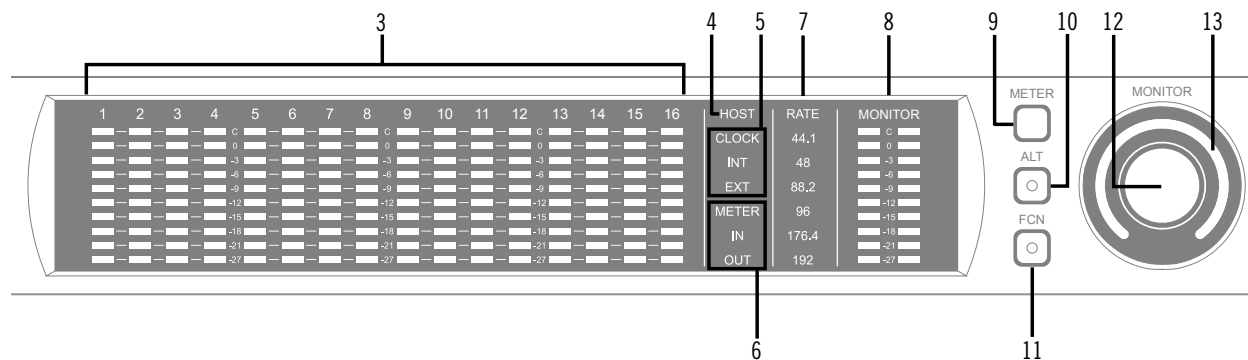

Main Apollo x16 front panel elements

(3) Channel Level Meters

The 10-segment LED channel meters display the input or output signal peak levels for analog channels 1 – 16. Input or output metering is selected with the METER switch (#9), and the input/output state is shown by the METER indicators (#6).

The dB values of the meter LEDs are indicated between the meters for channels 4 & 5 and 12 & 13. “0” indicates a level of 0 dBFS. When digital clipping occurs (when 0 dBFS is exceeded), the red “C” (clip) LED illuminates.

Input Channel Meters

When set to INPUT, the channel meters display the signal peak input levels for analog channels 1 – 16 at the input to the A/D converters. Avoid digital clipping at the channel’s A/D converter by reducing the output level of the device connected to the channel’s input.

Output Channel Meters

When set to OUTPUT, the channel meters display the signal peak output levels for analog channels 1 – 16 at the output of the D/A converters.

(4) HOST Indicator

The HOST indicator displays the status of the Thunderbolt connection to the host computer system. The possible states are:

Lit – The unit is communicating with the host computer and operating normally.

Unlit – The unit is starting up or it is not recognized by the host computer. Verify software installation and Thunderbolt connections.

Red – System error. Please contact UA technical support if the issue persists.

(5) CLOCK Indicators

The clock source and status are displayed with these indicators. Either internal (INT) or external (EXT) is displayed. The clock source is set within the Console application; see the Apollo Software Manual for details.

Internal Clock

When set to internal clock, the INT indicator is illuminated white.

External Clock

Apollo x16 can use an external digital clock source from the Word Clock or AES/EBU inputs. The EXT indicator has two possible states:

White – When set to external clock and a valid clock signal is detected at the specified port, the EXT indicator is illuminated white and Apollo x16 is synchronized to the external clock source.

Red – When set to external clock and a valid clock signal is NOT detected at the specified port, the EXT indicator is illuminated red and the internal clock remains active instead. In this situation, if/when the specified external clock becomes available, Apollo x16 switches back to the external clock, and the EXT indicator is illuminated and white.

Important: When set to use any external clock source, Apollo x16's sample rate must be manually set to match the sample rate of the external clock.

(6) METER Indicators

These indicators show the current state of the Channel Level Meters (#3). The current state is changed with the METER switch (#9).

IN – When IN is illuminated, the channel meters display analog input signal levels.

OUT – When OUT is illuminated, the channel meters display analog output signals levels.

(7) Sample Rate Indicators

These indicators display the current sample rate setting for A/D and D/A conversion. The sample rate is set within the Console application or the host DAW; see the Apollo Software Manual for details.

(8) Monitor Output Level Meters

The 10-segment LED meters display the signal peak output levels of the rear panel Left & Right Monitor outputs at the output of the D/A converters. These meters are before the Monitor Level control (pre-fader) and reflect the D/A converter levels regardless of the current Monitor Level and Headphone Level knob settings.

The dB values of the monitor meter LEDs are indicated between the left and right channel meters. When digital clipping occurs, the red “C” (clip) LED illuminates.

If the monitor output level clips, reduce the monitor output level within the DAW and/or reduce the output level of individual channels feeding the monitor output bus within the Console application.

(9) Meter Switch

This switch determines whether the Channel Level Meters (#3) are displaying input levels or output signal levels. Pressing the switch toggles the state of the meters and the Meter Indicators (#6).

(10) Monitor ALT Switch

When ALT monitoring is configured in the Hardware panel within the Console Settings window (when ALT COUNT is set to a non-zero value), this switch toggles between the main monitor outputs and the ALT 1 outputs (line outputs 1 & 2).

When the ALT switch is engaged:

- The monitor signals are routed to outputs 1 & 2 instead of the main monitor outputs.
- The orange LED within the switch is illuminated.
- The Monitor Level Indicator (#13) is orange instead of green.

For complete details about how to configure and use the ALT monitoring features, refer to the [Apollo Software Manual](#).

***Tip:** ALT 2 outputs (line outputs 3 & 4) can be selected with the FCN switch (#11) when configured in Console Settings, or in the MONITOR column within the Console application.*

(11) Monitor Function Switch (FCN)

This is an assignable switch that can be configured to control one of three monitoring functions. The function of the switch is configured with the FCN SWITCH ASSIGN menu in the Hardware panel within the Console Settings window. Refer to the [Apollo Software Manual](#) for details.

The amber LED within the switch flashes when the monitoring function is active. The function is toggled with the switch is pressed again. The available functions are:

ALT 2 – Selects the ALT 2 monitor speakers. The monitor signals are routed to outputs 3 & 4 instead of the main monitor outputs, and the Monitor Level Indicator ring (#13) is amber instead of green when ALT 2 is active.

MONO – Sums the left and right channels of the stereo monitor mix into a monophonic signal. The Monitor Level Indicator ring (#13) flashes when MONO is active.

DIM – Attenuates the signal level at the monitor outputs by the dB amount set in the CONTROL ROOM strip within the Console application. The Monitor Level Indicator ring (#13) flashes when DIM is active.

TALKBACK – Activates the talkback mic and the DIM function. Talkback is active when the button is lit. Press and release the button quickly to latch talkback ON. To momentarily activate the function and deactivate when the button is released, press for longer than 0.5 seconds. The Monitor Level Indicator ring (#13) flashes when talkback is active.

Note: *When more than one Apollo interface is connected in a multi-unit configuration, the FCN switch is operable on the designated monitor unit only.*

(12) Monitor Level & Mute Knob

This rotary encoder serves two functions. Rotating the knob adjusts the monitor output level, and pressing the knob mutes the monitor outputs.

Monitor Level

Rotating the knob clockwise increases the signal level at the Left & Right Monitor Outputs on the rear panel. If ALT monitor outputs are configured and active, this knob controls the signal level at the ALT monitoring line outputs.

Monitor Mute

Pressing the Monitor knob toggles the mute state of the signals at the Left & Right Monitor Outputs on the rear panel. If ALT monitoring is configured in the Hardware panel within the Console Settings window (when ALT COUNT is a non-zero value), the ALT monitor outputs are also muted by this control.

When the monitor outs are muted, the Monitor Level Indicator ring (#13) is red.

(13) Monitor Level & Monitor State Indicator

Tip: The Monitor Level and Monitor State indications are reflected in the Monitor column within the Console application.

Monitor Output Level Indicator

The relative signal level at the rear panel monitor outputs (and ALT monitor outputs, if configured) is indicated by the illuminated ring surrounding the Monitor Level knob.

This indicator is after the Monitor Level control (post fader). The ring indicates relative gain levels and is not calibrated to indicate any specific dB value.

Tip: Precise numerical dB gain values for the Monitor Level Knob are displayed within the Console application.

Monitor State Indicator

The color of the indicator ring indicates the current state of the monitor outputs:

Green – The main monitor outputs are active with variable level control.

Red – The main monitor outputs (and ALT monitor outputs, if configured) are muted.

Orange – The ALT 1 monitor outputs are active.

Amber – The FCN switch is active and assigned ALT 2.

Flashing – The monitor DIM, MONO, and/or TALKBACK functions are active.

(14) Power Switch

This switch applies power to Apollo x16. When the unit is powered on, the Universal Audio logo (#5) is illuminated. The external power supply must be properly connected for this switch to function.

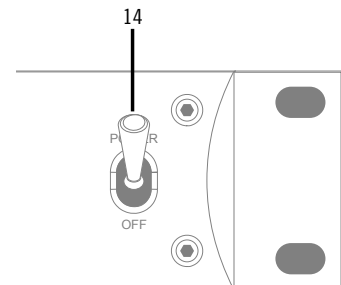

Rear Panel

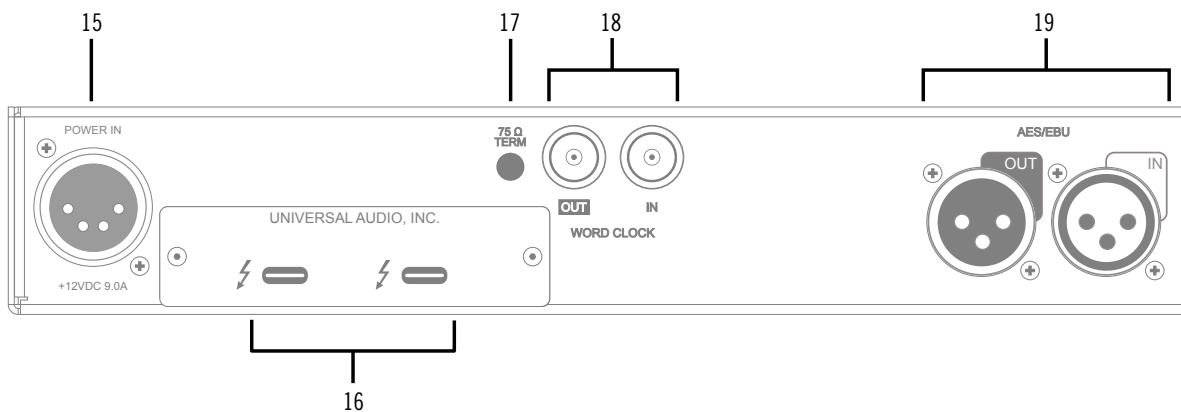

Apollo x16 rear panel (digital portion)

(15) Power Input

The included external power supply connects to this 4-pin locking XLR jack. Apollo x16 requires 12 volts DC power and draws a maximum of 72 watts (30 watts typical).

To eliminate risk of circuit damage, connect only the factory-supplied power supply. Use the Power switch on the front panel to power the unit on and off.

Important: Do not disconnect the power supply while Apollo x16 is in use, and confirm the Power switch is in the “off” position before connecting or disconnecting the power supply.

(16) Thunderbolt 3 Ports

Apollo x16 has two Thunderbolt 3 ports. One port is used to connect Apollo x16 to a Thunderbolt 3 port on the host computer. Thunderbolt 3 peripheral devices may be serially connected (daisy-chained) to the second Thunderbolt 3 port.

When Apollo x16 is properly communicating with the host computer via Thunderbolt, the HOST indicator (#4) illuminates.

Note: Apollo x16 can be used with Thunderbolt 1 and Thunderbolt 2 ports on Apple Mac computers via the Apple Thunderbolt 3 to Thunderbolt 2 Adapter. Connections to Thunderbolt 1 or Thunderbolt 2 ports on Windows PCs are not supported.

Thunderbolt Bus Power

Per the Thunderbolt specification, bus power is supplied to downstream (daisy-chained) Thunderbolt peripheral devices. Apollo x16 must be powered on for the daisy-chained peripheral to receive Thunderbolt bus power.

Digital I/O

(17) 75 Ohm Word Clock Termination Switch

This switch provides internal 75-ohm word clock input signal termination when required. Word clock termination is active when the switch is engaged (depressed).

Apollo x16's termination switch should only be engaged when Apollo x16 is set to sync to external word clock and it is the last device at the receiving end of a word clock cable. For example, if Apollo x16 is the last "slave" unit at the end of a clock chain (when Apollo x16's word clock OUT port is not used), termination should be active.

(18) Word Clock I/O

Word Clock In

Apollo x16's internal clock can be synchronized (slaved) to an external master word clock. This is accomplished by setting Apollo x16's clock source to Word Clock within the Console application, connecting the external word clock's BNC connector to Apollo x16's word clock input, and setting the external device to transmit word clock. If Apollo x16 is the last device in the clock chain, the Termination switch (#17) should be engaged.

Important: *Apollo x16's sample rate must be manually set to match the incoming clock's sample rate.*

Note: *Apollo x16 can be synchronized to an external "1x" clock signal only. Superclock, overclocking, and subclocking are not supported.*

Word Clock Out

This BNC connector transmits a standard (1x) word clock when Apollo x16 is set to use its internal clock. The clock rate sent by this port matches the current system sample rate, as specified within the Console application.

When Apollo x16 is set to use external word clock as its clock, Apollo x16 is a word clock slave. If the incoming external word clock is within $\pm 4\%$ of a supported sample rate (44.1 kHz, 48 kHz, 88.2 kHz, 96 kHz, 176.4 kHz, 192 kHz), Word Clock Out will mirror Word Clock In with a slight phase delay (about 40ns).

Because Apollo x16's word clock output is not a true mirror of the word clock input, word clock out should not be used to daisy chain the word clock if Apollo x16 is in the middle of the word clock chain. The correct method to connect Apollo x16 in the middle of a word clock chain is to use a T-connector at Apollo x16's word clock input and leave Apollo x16's word clock output unconnected. In this configuration, the Termination switch should not be engaged.

(19) AES/EBU Ports

The AES/EBU ports provide two channels of digital I/O with resolutions up to 24-bit at 192 kHz via XLR connectors. For optimum results, use only high-quality 110-ohm XLR cables specifically designed for AES/EBU digital audio.

SR Convert

Sample rate conversion can be enabled on the AES/EBU input. This function is set in the AES/EBU input channel strip within the Console application. When sample rate conversion is enabled and the sample rate of the incoming AES/EBU signal does not match the sample rate specified in the Console application, the AES/EBU signal is converted to match Apollo x16's sample rate.

***Note:** When Apollo x16 is set to use AES/EBU as the master clock source, sample rate conversion is inactive.*

Mirror Monitor Outputs

The AES/EBU output can be configured to mirror the Monitor outputs, for routing the stereo Monitor signal to the stereo AES/EBU input of other devices. This feature is set with the DIGITAL MIRROR menu in the Hardware panel within the Console Settings window.

Analog I/O

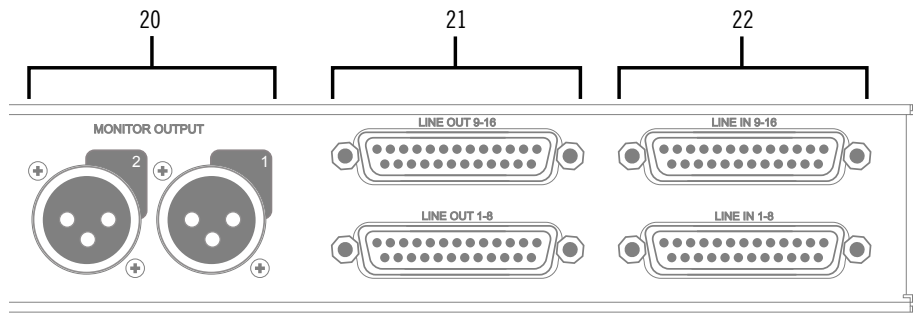

Apollo x16 rear panel (analog portion)

(20) Left & Right Monitor Outputs

These balanced XLR jacks are line-level analog outputs typically used for connection to a stereo loudspeaker monitoring system. The signal levels at these outputs are controlled with the Monitor Level & Mute knob (#12). The Monitor Outputs are DC coupled.

The Monitor Outputs can be configured to use an operating level of +4 dBu (default value) or -10 dBV. This option is set in the Hardware panel within the Console Settings window. For details, refer to the [Apollo Software Manual](#).

The Monitor Outputs are completely independent from the 16 line outputs (except when ALT monitoring is configured). By default, these outputs are labeled MON L and MON R in Apollo's device drivers. In the DAW, the "1-2" or "L-R" or "Main" outputs are routed to these outputs (these labels vary within each particular DAW).

Tip: The AES/EBU output (#19) can be configured to mirror the Monitor Outputs, for routing the stereo monitor signal to the stereo AES/EBU input of other devices. This feature is set with the DIGITAL MIRROR menu in the Hardware panel within the Console Settings window.

(21) Line Outputs 1 – 16

The 16 analog outputs are accessed via dual female DB25 connectors. Each DB25 jack carries eight balanced line-level channel outputs using standardized Tascam wiring. The Line Outputs are DC coupled.

Note: See [DB25 Wiring](#) for connector pinouts.

Line Output Headroom

By default, the operating level of the line outputs is +20 dBu. The line outputs and inputs can be globally configured to operate at +24 dBu signal levels with the HEADROOM menu in the Settings>Hardware panel within the Console application.

+24 dBu operation is typically used for interfacing with professional audio equipment such as large format consoles, analog tape machines, and similar devices that require higher signal levels. For additional details about +24 dBu operation, see the Apollo Thunderbolt Software Manual.

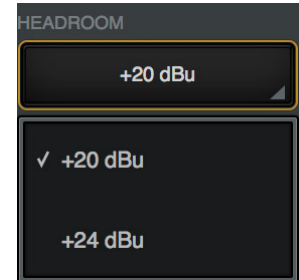

*Headroom menu
within Console Settings*

Line Output Reference Levels

The Line Outputs can be configured in adjacent pairs to use either –10 dBV or +4 dBu reference levels. This function is configured in the Hardware panel within the Console Settings window. Refer to the [Apollo Software Manual](#) for details.

ALT Outputs 1 – 4

Apollo x16 features ALT (alternate) monitoring capabilities. ALT monitoring can be used to control up to two alternate pairs of monitor speakers.

When ALT monitoring is enabled, the output level and muting of line outputs 1 & 2 (ALT 1) and 3 & 4 (ALT 2) are controlled by the Monitor Level & Mute knob (#12). ALT monitoring is enabled in the Hardware panel within the Console Settings window by increasing the ALT COUNT setting to a non-zero value.

(22) Line Inputs 1 – 16

The 16 analog inputs are accessed via dual female DB25 connectors. Each DB25 jack carries eight balanced line-level channel inputs using standardized Tascam pinouts. The Line Inputs are DC coupled.

Note: See [DB25 Wiring](#) for connector pinouts.

Line Input Headroom

By default, the operating level of the line inputs is +20 dBu. The line inputs and outputs can be globally configured to operate at +24 dBu signal levels with the HEADROOM menu in the Settings>Hardware panel within the Console application.

+24 dBu operation is typically used for interfacing with professional audio equipment such as large format consoles, analog tape machines, and similar devices that require higher signal levels. For additional details about +24 dBu operation, see the Apollo Thunderbolt Software Manual.

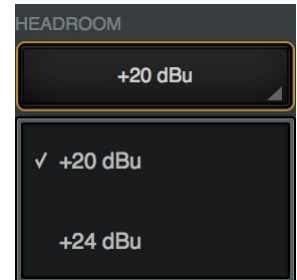

Headroom menu within Console Settings

Line Input Reference Levels

The Line Inputs can be individually configured to use –10 dBV or +4 dBu reference levels. This option is set in the channel input strips within the Console application. Refer to the [Apollo Software Manual](#) for details.

Interconnections

Installation Notes

- Apollo X may get hot during normal operation if it doesn't receive adequate airflow circulation around its chassis vents. For optimum results when mounting Apollo X in a rack, leaving at least one empty rack space above the unit to allow adequate airflow for cooling is strongly recommended.
- If Apollo X is installed near other heat generating equipment, external cooling (such as a fan) may be needed to keep the ambient temperature below 104°F (40°C).
- As with any sound system, the following steps are recommended to avoid audio spikes in your speakers and headphones:
 1. Apply power to the speakers last, after all other devices (including Apollo X) are powered on.
 2. Turn off the speakers first, before all other devices (including Apollo X) are powered off.
 3. Remove headphones from ears before powering Apollo X on or off.

Connection Notes

Thunderbolt

- Apollo X must be connected via a Thunderbolt 3 cable (not included) to computers that have Thunderbolt 3 ports.*
- Connect only one Thunderbolt 3 cable between Apollo X and the host computer. Thunderbolt is a bidirectional protocol.
- Apollo X cannot be bus powered via Thunderbolt. The included external power supply must be used.
- Thunderbolt bus power is supplied to downstream (daisy-chained) peripheral devices. Apollo X must be powered on for the daisy-chained peripheral to receive Thunderbolt bus power.

**Note: With Mac computers only, Apollo X can be connected to Thunderbolt 1 and Thunderbolt 2 computer ports via the Apple Thunderbolt 3 to Thunderbolt 2 adapter. Visit help.uaudio.com for details.*

Apollo Expanded

- When more I/O and/or DSP is needed, up to four Apollo interfaces and six UAD devices total can be cascaded together via Thunderbolt in a multiple-unit configuration. For complete details about multi-unit cascading, refer to the [Apollo Software Manual](#).

About Thunderbolt 3 Ports and Cables

Important: Although Thunderbolt 3 always uses USB-C connectors, not all USB-C ports are Thunderbolt 3 ports. Similarly, not all USB-C cables are Thunderbolt 3 cables. Always connect Apollo x16 to a Thunderbolt 3 port with a Thunderbolt 3 cable.

USB-C is not Thunderbolt 3

Thunderbolt 3 uses USB-C connections to transfer data and power. However, USB-C is simply a connector type; it doesn't determine the type of data used by the connector. For example, USB-C connections can be used for Thunderbolt 3, USB 3.1, and other data protocols, so USB-C connections are not always interchangeable.

Does your USB-C connector support Thunderbolt 3?



To determine if a USB-C port or cable connector supports Thunderbolt 3, look for the Thunderbolt icon. The Thunderbolt icon on a USB-C port or cable means the connector supports Thunderbolt 3. Alternately, confirm Thunderbolt 3 compatibility with the device and/or cable manufacturer.



Thunderbolt icon on USB-C cable (left) and USB-C port (right)

Typical Setup

This diagram illustrates an Apollo x16 example system.

Key points for this example:

- Either Thunderbolt 3 port can be used for the host computer connection
- The Monitor outputs are connected to powered monitors (or an amp+speaker system)
- DB25 audio snakes are used for connections to line-level audio gear
- Although this example uses XLR connectors, DB25 snakes that terminate to XLR, TRS, or other DB25 connectors can be used

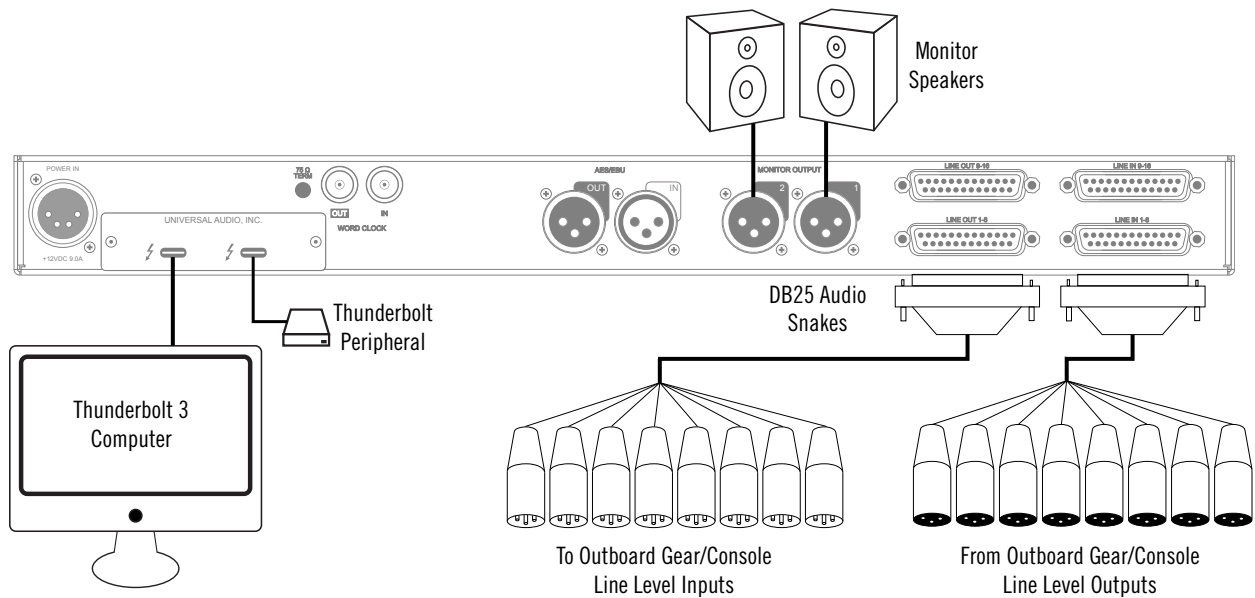

Typical Apollo x16 connections

Apollo Expanded: Multi-Unit Thunderbolt 3 Wiring

The diagram below illustrates an example of how to interconnect multiple Apollo units and the host computer via Thunderbolt 3.

Important: For complete details about system operation when multi-unit cascading, see the [Apollo Software Manual](#).

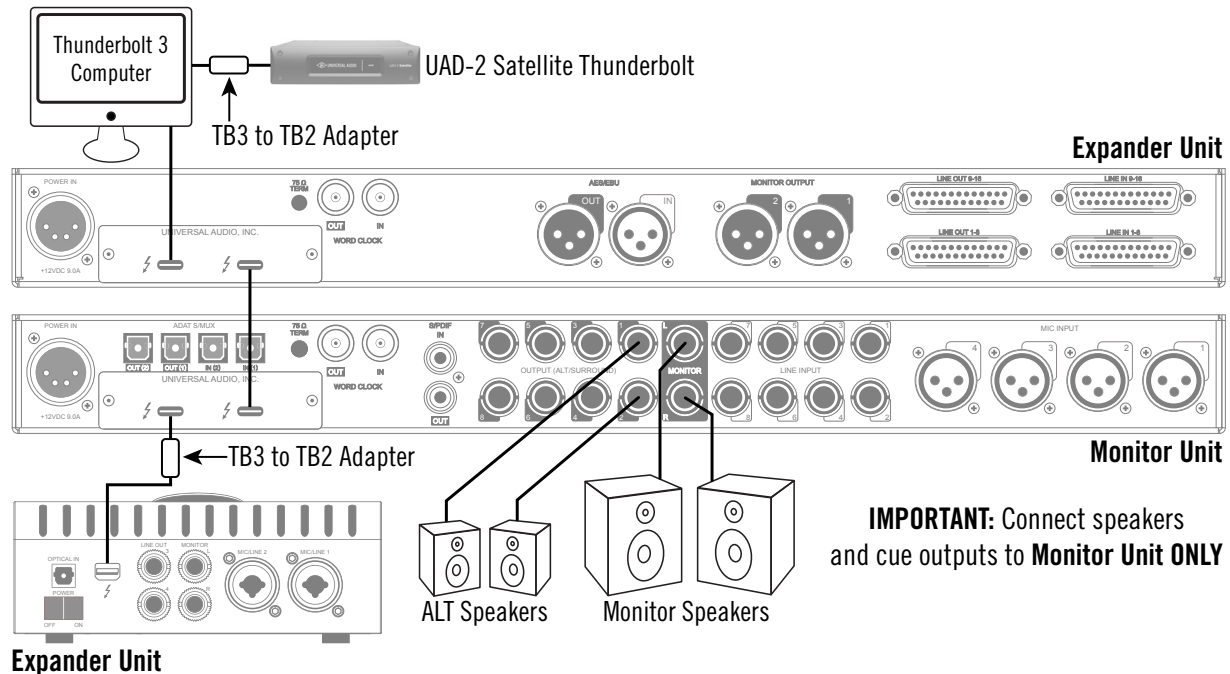

Connecting multiple Apollo X units via Thunderbolt 3

Apollo Expanded Wiring Notes

- Apollo device ordering and Thunderbolt ports used (second port on Apollo vs. second port on computer, placement within daisy chain, etc) is not important.
- In this example diagram, an Apollo x8 is the monitor (master) unit designated in the Console Settings window. Connect speakers (including ALT speakers) and any cue outputs to the monitor unit only.
- Do not interconnect any Word Clock, FireWire, ADAT, or MADI ports between any Apollo units. All Apollo clocking is automatically managed via Thunderbolt.
- Up to four Apollo units and six UAD devices total can be combined within the same system.
- The computer and all Apollo/UAD units must be connected to the same Thunderbolt bus.
- Apollo X-series units with Thunderbolt 3 can be mixed with older Apollo units with Thunderbolt 2 by using compatible Thunderbolt 3 to Thunderbolt 2 adapters.

Note: On Mac systems only, Apollo X can be connected to Thunderbolt 1 and Thunderbolt 2 computers via the Apple Thunderbolt 3 to Thunderbolt 2 adapter. Visit help.uaudio.com for details.

Software Setup

Note: Items on this page are detailed in the [Apollo Software Manual](#).

System Requirements

All system requirements must be met for Apollo X to operate properly. Before proceeding with installation, see the system requirements in the Apollo Software Manual.

Software Installation

The software must be installed to use the hardware and UAD plug-ins. The UAD Powered Plug-Ins software installer contains the Apollo X software, drivers, and UAD plug-ins.

Registration and Authorization

Apollo X must be registered and authorized to unlock UAD plug-ins that are bundled with the product. To register and authorize Apollo x16, visit:

- www.uaudio.com/register

Note: For optimum results, connect and power on Apollo X before installing the software.

Latest Software

To obtain the latest UAD installer after initial registration, visit:

- www.uaudio.com/downloads

System Configuration

Complete details about setting up the Apollo X system, including how to integrate with a DAW and related information, are included in the Apollo Software Manual.

Console Application

The included Console application is the software interface for the Apollo X hardware. Console controls Apollo X and its digital mixing, monitoring, and Realtime UAD Processing features. Console is also used to configure Apollo X I/O settings such as sample rate, clock source, and reference levels.

For complete details about how to operate Console, refer to the Apollo Software Manual.

UA Support Videos

Informational videos are available to help you get started with Apollo X:

- help.uaudio.com

Specifications

All specifications are typical performance unless otherwise noted. Tested with the Audio Precision APx555 Audio Analyzer under the following conditions: 48 kHz internal sample rate, 24-bit sample depth, 20 kHz measurement bandwidth, +24 dBu headroom, balanced output, and internal clock.

SYSTEM	
<i>I/O Complement</i>	
Analog Line Inputs	16
Analog Line Outputs (DC coupled)	16
Analog Monitor Outputs (DC coupled)	Two (one stereo pair)
AES/EBU	One stereo input, one stereo output
Thunderbolt 3 Ports	Two
Word Clock	One input, one output
<i>A/D – D/A Conversion</i>	
Simultaneous A/D conversion	16 channels
Simultaneous D/A conversion	18 channels
Supported Sample Rates (kHz)	44.1, 48, 88.2, 96, 176.4, 192
Bit Depth Per Sample	24
Analog Round-Trip Latency	1.1 milliseconds @ 96 kHz sample rate
Analog Round-Trip Latency through four UAD legacy plug-ins (included) via Console software	1.1 milliseconds @ 96 kHz sample rate (no additional latency via Realtime UAD Processing)

(continued)

ANALOG I/O	
<i>Line Inputs 1 – 16</i>	
Frequency Response	20 Hz – 20 kHz, ± 0.05 dB
Dynamic Range	124 dB (A-weighted)
Total Harmonic Distortion + Noise Ratio (1 kHz @ 23 dBu)	-115 dB (0.000180%)
Maximum Input Level (Reference Level @ +4 dBu)	24 dBu, Balanced
Maximum Input Level (Reference Level @ -10 dBV)	6.2 dBV (8.4 dBu), Balanced
Input Impedance	10k Ohms
Connector Type	Two Female DB25, Tascam wiring
<i>Line Outputs 1 – 16</i>	
Frequency Response	20 Hz – 20 kHz, ± 0.02 dB
Dynamic Range	127 dB (A-weighted)
Total Harmonic Distortion + Noise Ratio (1 kHz @ -1 dBFS)	-123 dB (0.000068%)
Maximum Output Level (Reference Level @ +4 dBu)	24 dBu (21.8 dBV)
Maximum Output Level (Reference Level @ -10 dBV)	10 dBV (12.2 dBu)
Output Impedance	100 Ohms
Connector Type	Two Female DB25, Tascam wiring
<i>Monitor Outputs 1 – 2</i>	
Frequency Response	20 Hz – 20 kHz, ± 0.02 dB
Dynamic Range	133 dB (A-weighted)
Total Harmonic Distortion + Noise Ratio (1 kHz @ -1 dBFS)	-129 dB (0.000037%)
Maximum Output Level (Reference Level @ +4 dBu)	24 dBu (21.8 dBV)
Maximum Output Level (Reference Level @ -10 dBV)	10 dBV (12.2 dBu)
Output Impedance	100 Ohms
Connector Type	Balanced Male XLR (pin 2 hot)
DIGITAL I/O	
<i>AES/EBU</i>	
Connector Type	XLR
Format	IEC 60958 Type I
<i>Word Clock</i>	
Connector Type	BNC
Lock Range	$\pm 4\%$ of any supported sample rate
Word Clock Input Termination	75 Ohms, switchable
<i>Synchronization Sources</i>	
Internal, Word Clock, AES/EBU	

(continued)

ELECTRICAL	
Power Supply	External AC-to-DC Power Supply, Level VI compliant
AC Input Connector Type	IEC Male
AC Requirements	100V – 240V AC, 50 – 60 Hz
DC Connector Type	XLR 4-Pin Locking Male (Neutrik P/N NC4MDM3-H)
DC Requirements	12 VDC, 6A
Maximum Power Consumption	72W (30W typical)
ENVIRONMENTAL	
Ambient Temperature Range	32° to 104° F (0° to 40° C)
MECHANICAL	
<i>Dimensions</i>	
Width	19 in (48,26 cm)
Height (1U rack space)	1.75 in (4,45 cm)
Depth, Chassis Only	12.125 in (30,80 cm)
Depth, Including Knob & Jack Protrusions	13.5 in (34,29 cm)
Shipping Box (Width x Depth x Height)	23.5 in x 17 in x 7.5 in (59,69 cm x 43,18 cm x 19,05 cm)
<i>Weight</i>	
Shipping Weight (with box & accessories)	USA: 16.6 lbs (7.52 kg) EU & UK: 16.9 lbs (7.64 kg)
Weight (bare unit)	9 lbs (4.08 kg)
<i>Package Contents</i>	
Apollo x16 Audio Interface Unit	
External Power Supply	
AC Power Cable (IEC), Region Specific	
Set of (4) Rack-Mount Screws	
Getting Started URL Card	

Hardware Block Diagram

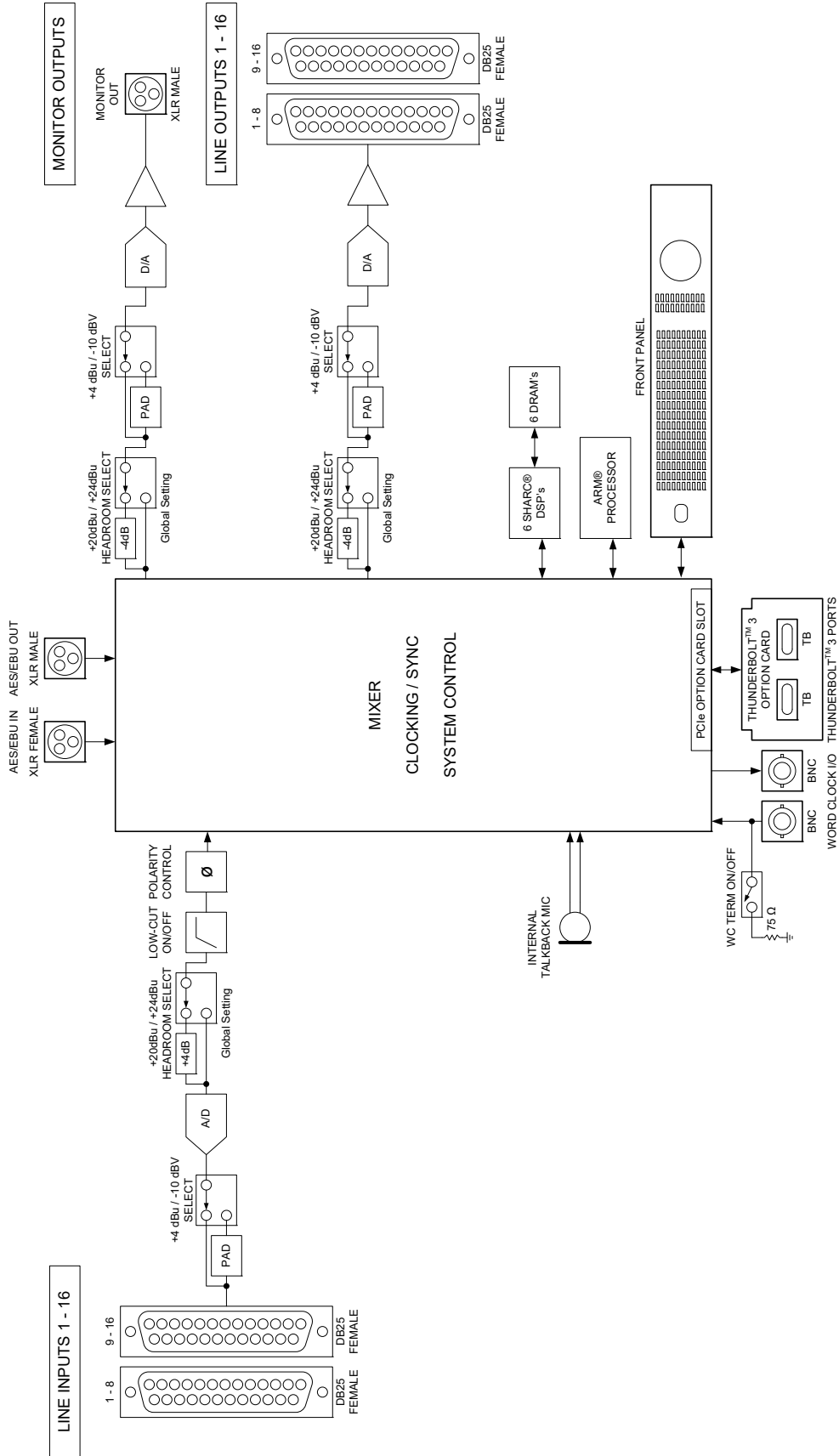

Apollo x16 Hardware Block Diagram V02

DB25 Wiring

Apollo x16's analog I/O is accessed via 25-pin D-sub female connectors. Each DB25 jack carries eight balanced line-level audio channels on the standardized Tascam pinouts also used with Digidesign and Avid products.

DB25 Connector Pin Numbers

The pin numbers for female DB25 connectors are shown in the diagram below. When facing the Apollo x16 rear panel, pin 1 is the upper rightmost pin.

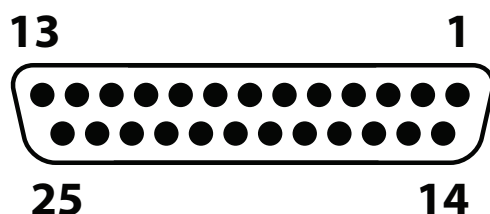

Apollo x16 female DB25 pin numbers

DB25 Connector Wiring

The signals carried on the female DB25 connector pins are listed in the table below. Two channels are listed for each pin. The first is for the connector carrying channels 1 – 8; the second is for the connector carrying channels 9 – 16.

Note: Pinouts are identical for inputs and outputs.

Apollo x16 DB25 Connector Pinouts								
Pin	Channels	Signal	Pin	Channels	Signal	Pin	Channels	Signal
1	8, 16	Hot	9	3, 11	Cold	17	6, 14	Cold
2	8, 16	Ground	10	2, 10	Hot	18	5, 13	Hot
3	7, 15	Cold	11	2, 10	Ground	19	5, 13	Ground
4	6, 14	Hot	12	1, 9	Cold	20	4, 12	Cold
5	6, 14	Ground	13	–	No Connect	21	3, 11	Hot
6	5, 13	Cold	14	8, 16	Cold	22	3, 11	Ground
7	4, 12	Hot	15	7, 15	Hot	23	2, 10	Cold
8	4, 12	Ground	16	7, 15	Ground	24	1, 9	Hot
						25	1, 9	Ground

Troubleshooting

If Apollo x16 isn't behaving as expected, here are some common troubleshooting items to confirm. If you are still experiencing issues after performing these checks, contact [Technical Support](#).

SYMPTOM	ITEMS TO CHECK
Unit won't power on	<ul style="list-style-type: none"> • Confirm power supply connections at power supply input and back of unit • Confirm Power switch is not in "OFF" position • Confirm AC power is available at wall socket by plugging in a different device
No monitor output	<ul style="list-style-type: none"> • Confirm connections, power, and volume of monitoring system • Confirm monitor knob is turned up • Confirm monitor outputs are not muted (press monitor knob) • Confirm monitor LEDs are active (check signal flows)
Monitor output level range is too loud or too quiet	<ul style="list-style-type: none"> • Monitor output reference levels can be switched between +4 dBu and -10 dBV in the Hardware panel within the Console Settings window
Input levels are too high or too low	<ul style="list-style-type: none"> • Input reference levels can be switched between +4 dBu and -10 dBV in the input channel strips within the Console application
Can't fine tune input signal levels	<ul style="list-style-type: none"> • Signal levels for all inputs, including digital inputs, are adjusted at the device connected to those inputs
Output levels are too high or too low	<ul style="list-style-type: none"> • Output reference levels for adjacent pairs can be switched between +4 dBu and -10 dBV in the Hardware panel within the Console Settings window
Audio glitches and/or dropouts during playback	<ul style="list-style-type: none"> • Increase audio I/O buffer size setting in DAW • Confirm clocking setups (check cable connections and confirm all device clocks are synchronized to one master clock device)
Undesirable echo/phasing	<ul style="list-style-type: none"> • Confirm input monitoring is not enabled in both Console and DAW
HOST indicator is unlit or red	<ul style="list-style-type: none"> • Confirm Thunderbolt connections • Confirm UAD Powered Plug-Ins software is installed • Power Apollo off then power on Apollo, and restart computer • Reinstall Apollo x16 software • Try a different Thunderbolt cable
Faint static and/or white noise is heard when nothing is plugged in	<ul style="list-style-type: none"> • Mute unused inputs • Some UAD plug-ins model the noise characteristics of the original equipment; defeat the noise model in the UAD plug-in interface, or mute the channel containing the plug-in to temporarily mute the noise
Various LEDs inside the unit are blinking	<ul style="list-style-type: none"> • This is normal operational behavior that can be safely ignored
Apollo x16 is behaving unexpectedly	<ul style="list-style-type: none"> • As a last resort, perform a hardware reset on the unit by following these steps: <ol style="list-style-type: none"> 1. Power off Apollo x16 2. Press and hold the METER and MONITOR controls 3. Power on Apollo x16 while continuing to hold both controls 4. After all front panel LEDs flash rapidly (after several seconds), release the controls.

Notices

Warranty

Universal Audio provides a limited warranty on all UA hardware products. To learn more, visit help.uaudio.com. The limited warranty gives you specific legal rights. You may also have other rights which vary by state or country.

Repair Service

If you are having trouble with Apollo X, first check all system setups, connections, and operating instructions. If that doesn't help, contact our technical support team.

To learn about repair service, or for technical support, visit help.uaudio.com.



Maintenance

- **CAUTION:** To reduce the risk of electric shock, do not open the unit.
- Apollo X does not contain a fuse or any other user-replaceable parts. The unit is internally calibrated at the factory. No internal user adjustments are available.

Important Safety Information



Before using this unit, be sure to carefully read the applicable items of these operating instructions and the safety suggestions. Afterwards, keep them handy for future reference. Take special care to follow the warnings indicated on the unit, as well as in the operating instructions.

- 1) Read these instructions.
- 2) Keep these instructions.
- 3) Heed all warnings.
- 4) Follow all instructions.
- 5) Do not use this apparatus near water.
- 6) Clean only with dry cloth.
- 7) Do not block any ventilation openings. Install in accordance with the manufacturer's instructions.
- 8) Do not install near any heat source such as radiators, heat registers, stoves, or other apparatus (including amplifiers) that produce heat.
- 9) Do not defeat the safety purpose of the polarized or grounding-type plug. A polarized plug has two blades with one wider than the other. A grounding type plug has two blades and a third grounding prong. The wide blade or the third prong are provided for your safety. If the provided plug does not fit into your outlet, consult an electrician for replacement of the obsolete outlet.
- 10) Protect the power cord from being walked on or pinched particularly at plugs, convenience receptacles, and the point where they exit from the apparatus.
- 11) Only use with attachments/accessories specified by the manufacturer.
- 12) Use only with the cart, stand, tripod, bracket, or table specified by the manufacturer, or sold with the apparatus. When a cart is used, use the caution when moving the cart/apparatus combination to avoid injury from tip-over.
- 13) Unplug this apparatus during lightning storms or when unused for long periods of time.
- 14) Refer all servicing to qualified service personnel. Servicing is required when the apparatus has been damaged in any way, such as power-supply cord or plug is damaged, liquid has been spilled or objects have fallen into the apparatus, the apparatus has been exposed to rain or moisture, does not operate normally, or has been dropped.

Description of symbols used



The lightning flash represented by the arrow symbol in an equilateral triangle is intended to alert users to the presence of high voltage within the unit that could cause an electrical shock hazard.



The exclamation mark in an equilateral triangle is intended to alert users to the existence of important instructions in the manual relating to the use and maintenance of the unit.

FCC Compliance

Federal Communications Commission United States Class A Manual Statements

Note: This equipment has been tested and found to comply with the limits for a Class A digital device pursuant to Part 15 of the FCC Rules. These limits are designed to provide reasonable protection against harmful interference when the equipment is operated in a commercial environment. This equipment generates, uses, and can radiate radio frequency energy and, if not installed and used in accordance with the instruction manual, may cause harmful interference to radio communications. Operation of this equipment in a residential area is likely to cause harmful interference to radio communications. Operation of this equipment in a residential area is likely to cause harmful interference in which case the user will be required to correct the interference at their own expense.

Any modifications to the unit, unless expressly approved by Universal Audio, could void the User's authority to operate the equipment.

- Canada: Innovation, Science and Economic Development Canada Interference Causing Equipment Standard ICES-003, Issue 6, dated January 2016 (class A)
- Japan: VCCI-CISOR 32:2016, "Technical Requirements" for multimedia equipment (class A)
- EN 55022:2010, "Information technology equipment – Radio disturbance characteristics – Limits and method of measurements" (Class A)
- CISPR 22:2008, "Information technology equipment – Radio disturbance characteristics – Limits and method of measurement" (Class A)
- EN 55032:2010, "Electromagnetic compatibility of multimedia equipment – Emission Requirements"
- CISPR 32:2010, "Electromagnetic compatibility of multimedia equipment – Emissions requirements"
- EN 55024:2010, "Information technology equipment – Immunity characteristics. Limits and method of measurement"
- CISPR 24:2010 +A1:2015, "Information technology equipment – Immunity characteristics. Limits and method of measurement."
- TCVN 7189:2009, "Information technology equipment – Radio disturbance characteristics – Limits and method of measurements"
- Korea: KN32/KN35: 2015, Multimedia Class A

Disclaimer

The information contained in this manual is subject to change without notice. Universal Audio, Inc. makes no warranties of any kind with regard to this manual, including, but not limited to, the implied warranties of merchantability and fitness for a particular purpose. Universal Audio, Inc. shall not be liable for errors contained herein or direct, indirect, special, incidental, or consequential damages in connection with the furnishing, performance, or use of this material.

End User License Agreement

Your rights to the Software are governed by the accompanying End User License Agreement, a copy of which can be found at: www.uaudio.com/eula

Trademarks

Universal Audio, the Universal Audio “diamond” logo, Apollo, Apollo Twin, Apollo 16, Unison technology, UAD, UAD Series, UAD-1, UAD-2, UAD-2 Satellite, Powered Plug-Ins, 1176LN, 1176SE, Teletronix, LA-2A, LA-3A, LA-610, LA-610MkII, 2-1176, 2-610, 6176, 710 Twin-Finity, 2192, 4-710d, Cambridge EQ, DreamVerb, Plate 140, Precision Limiter, RealVerb Pro, Precision Buss Compressor, Precision De-Esser, Precision Maximizer, and “Analog Ears | Digital Minds,” are among the trademarks, trade names, and service marks owned by UA that may appear on the Site, many of which are registered in the United States and other countries. This is not a comprehensive list of all UA trademarks. All UA trademarks inure to the benefit of UA. Other trademarks and trade names that may appear on the Site and which are not owned by UA are owned by the respective owners.

Copyright

Copyright ©2018 Universal Audio, Inc. All rights reserved.

This manual and any associated software, artwork, product designs, and design concepts are subject to copyright protection. No part of this document may be reproduced, in any form, without prior written permission of Universal Audio, Inc.

Technical Support

Universal Audio Knowledge Base

The UA Knowledge Base is your complete technical resource for configuring, operating, troubleshooting, and repairing UA products.

You can watch helpful support videos, search the Knowledge Base for answers, get updated technical information that may not be available elsewhere, and more.

[UA Knowledge Base](#)

YouTube Support Channel

The Universal Audio Support Channel at youtube.com includes helpful support videos for setting up and using UA products.

[UA YouTube Support Channel](#)

Universal Audio Community Forums

The unofficial UA discussion forums are a valuable resource for all Universal Audio product users. This website is independently owned and operated.

www.uadforum.com

Contact Universal Audio Support

To contact UA support staff for technical or repair assistance, please visit:

help.uaudio.com

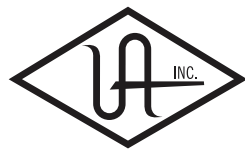

UNIVERSAL AUDIO